

MIL-DTL-38999 Fiber Optic Cable Sets for 'Harsh' Use

MIL38999 connectors based fiber optics Cable Sets are for HARSH environment military & naval applications. Based on MIL-C-85045 conformant tactical fiber optic cable which is extremely strong, lightweight & rugged. Also ideal for quick field deployment/rollback due to reduced size and weight. Available in deployable reel.



Optional reel available for deployment/retrieval



MIL-38999 Fiber Optic connectors

HARSH ENVIRONMENT APPLICATIONS

- Radars, Military Systems, Ground Control Systems, Launchers etc
- Excellent for deployment/retrieval applications like tactical communications
- Designed for extreme environmental conditions – temperature, humidity, ice, fungus and fluid immersion
- Rugged fiber optic cable with high tensile load for high survivability in severe crush, impact, vehicle runover, deployment and retrieval conditions
- Extremely strong, lightweight, rugged, survivable cable design for military use
- Polyurethane jacketed for abrasion, cut and chemical resistance

- **MIL-C-85045 Conformant , Optical Cable Corp., USA** or equivalent Fiber Optic cable
- **MIL-38999 Qualified Glenair/Amphenol** or equivalent connectors

MIL Standards Conformance

- MIL-DTL-38999
- MIL-PRF 85045
- MIL-PRF 29504

Tactical Cable Construction

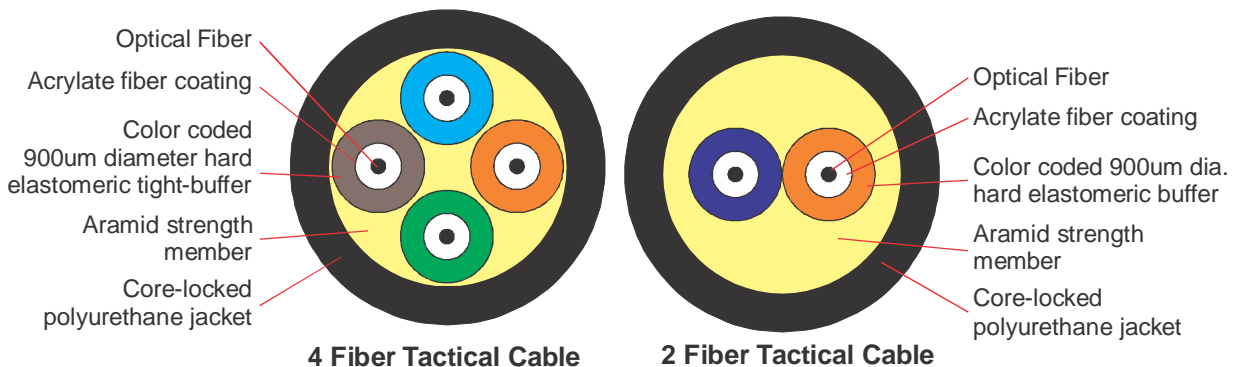

Designs available with 2, 4, 6, 8 or more fibers

Shown trademarks are property of their respective owners.

While the information contained herein in this catalog, has been carefully compiled to the best of our knowledge, nothing is intended as representation and warranty on our part; and no statement shall be construed as recommendation to infringe any of existing patents. We accept no liability of whatsoever for any faults and errors in the information contained herein. Contents of this catalogue and specifications of the products, are subject to change without notice due to continuous improvements.

Specifications for Military Tactical Cables

No of Fiber	Mode	Core/Cladding (um)	Cable Dia. mm	Weight kg/km	Tensile Load Max (N)		Bend Radius Min (cm)		Attenuation Min (dB/Km)		
					Install.	Oper.	Install	Oper.	850nm	1300nm	1550nm
2	Single	9/125	5	23	1800	600	8	4	-	0.5	0.5
4	Single	9/125	5.5	28	1800	600	8.8	4.4	-	0.5	0.5
8	Single	9/125	6.5	38	1800	600	10.4	5.2	-	0.5	0.5
2	Multi	62.5/125	5	23	1800	600	8	4	3.5	1.5	-
4	Multi	62.5/125	5.5	28	1800	600	8.8	4.4	3.5	1.5	-
8	Multi	62.5/125	6.5	38	1800	600	10.4	5.2	3.5	1.5	-

Environmental Specifications for MILitary Tactical Cables

Storage Temperature Range	-70 to +85°C
Operating Temperature Range	-55 to +85°C
Crush Resistance (MIL-85045/EIA-455-41)	440 N/cm
Impact Resistance (MIL-85045/EIA-455-25)	200 Impacts
Cyclic Flexing (MIL-85045/EIA-455-104)	2000 cycles, min.
Knot Force (MIL-85045/EIA-455-87)	500 N test force
Thermal Shock (MIL-85045/EIA-455-71)	-57 to +85°C
Temperature/Humidity (MIL-85045/EIA-455-5)	95%

How to Specify Part Numbers for Cable Sets:

STF - □ □ □ □ □ / □ □ □ □ □ - □ F / □ □ M / □ □ □ □ - □ □ □ □ □ - 00
A A A B C A A A B C N X X Y Y Y Y Z Z K K K

A	2 digit connector Code	9/125 SM MIL38999 Plug : 42 = size 11; 45 = size 13; 48 = size 17 50&62.5/125 MM MIL38999 Plug : 51 = size 11; 54 = size 13; 57 = size 17
B	Connector Type	Straight = S ; Rt. Angle= R ; Jamnut Recep. = J ; Wall Mt. Recep. = W
C	Connector Style	Male/Plug = P ; Female = J
D	Termini Style	Male/Plug = P ; Female/Socket = J
N	No. of Fibers	2 = 2 fibres; 4 = 4 fiber ; 8 = 8 fiber
XX	2 digit code for Mode	9S = 9/125um singlemode ; 5M = 50/125um multimode; 6M = 62.5/125um multimode ; CM = 50/125 & 62.5/125 multimode
YYY	Length	100 meter = 100M ; 1 Km = 1KM ; 1 feet = 1F
ZZ	2 digit cable code	DI = Distribution Style ; BR = Breakout; RI = Riser
KKK	Cable class code	Breakout = 023; Distribution = 065; Riser = 120

100m Cable Set SM 9/125um, 38999 St. Plug, 4 fibre = STF-45SPP/45SPP-4F/9SM/100M-DI065-00

Shown trademarks are property of their respective owners.

While the information contained herein in this catalog, has been carefully compiled to the best of our knowledge, nothing is intended as representation and warranty on our part; and no statement shall be construed as recommendation to infringe any of existing patents. We accept no liability of whatsoever for any faults and errors in the information contained herein. Contents of this catalogue and specifications of the products, are subject to change without notice due to continuous improvements.

Tactical Fiber Optic Cable Sets with MIL-38999 Connectors

P/N for Fiber Optic Assembly	Mode	Size	No. of Fibers	Conn. 1		Conn. 2		Len. meter
				type	size	type	size	
STF-42SPP/42SPP-2F/9SM/100M-DI065-00	Singlemode	9/125	2	Plug	11	Plug	11	100
STF-45SPP/45SPP-4F/9SM/100M-DI065-00	Singlemode	9/125	4	Plug	13	Plug	13	100
STF-48SPP/48SPP-8F/9SM/100M-DI065-00	Singlemode	9/125	8	Plug	17	Plug	17	100
STF-42SPP/42SPP-2F/9SM/200M-DI065-00	Singlemode	9/125	2	Plug	11	Plug	11	200
STF-45SPP/45SPP-4F/9SM/200M-DI065-00	Singlemode	9/125	4	Plug	13	Plug	13	200
STF-48SPP/48SPP-8F/9SM/200M-DI065-00	Singlemode	9/125	8	Plug	17	Plug	17	200
STF-42SPP/42SPP-2F/9SM/500M-DI065-00	Singlemode	9/125	2	Plug	11	Plug	11	500
STF-45SPP/45SPP-4F/9SM/500M-DI065-00	Singlemode	9/125	4	Plug	13	Plug	13	500
STF-48SPP/48SPP-8F/9SM/500M-DI065-00	Singlemode	9/125	8	Plug	17	Plug	17	500
STF-42SPP/42SPP-2F/9SM/600M-DI065-00	Singlemode	9/125	2	Plug	11	Plug	11	600
STF-45SPP/45SPP-4F/9SM/600M-DI065-00	Singlemode	9/125	4	Plug	13	Plug	13	600
STF-48SPP/48SPP-8F/9SM/600M-DI065-00	Singlemode	9/125	8	Plug	17	Plug	17	600
STF-42SPP/42SPP-2F/9SM/1KM-DI065-00	Singlemode	9/125	2	Plug	11	Plug	11	1KM
STF-45SPP/45SPP-4F/9SM/1KM-DI065-00	Singlemode	9/125	4	Plug	13	Plug	13	1KM
STF-48SPP/48SPP-8F/9SM/1KM-DI065-00	Singlemode	9/125	8	Plug	17	Plug	17	1KM
STF-51SPP/51SPP-2F/CMM/100M-DI065-00	Multimode	50 & 62.5/125	2	Plug	11	Plug	11	100
STF-54SPP/54SPP-4F/CMM/100M-DI065-00	Multimode	50 & 62.5/125	4	Plug	13	Plug	13	100
STF-57SPP/57SPP-8F/CMM/100M-DI065-00	Multimode	50 & 62.5/125	8	Plug	17	Plug	17	100
STF-51SPP/51SPP-2F/CMM/200M-DI065-00	Multimode	50 & 62.5/125	2	Plug	11	Plug	11	200
STF-54SPP/54SPP-4F/CMM/200M-DI065-00	Multimode	50 & 62.5/125	4	Plug	13	Plug	13	200
STF-57SPP/57SPP-8F/CMM/200M-DI065-00	Multimode	50 & 62.5/125	8	Plug	17	Plug	17	200
STF-51SPP/51SPP-2F/CMM/500M-DI065-00	Multimode	50 & 62.5/125	2	Plug	11	Plug	11	500
STF-54SPP/54SPP-4F/CMM/500M-DI065-00	Multimode	50 & 62.5/125	4	Plug	13	Plug	13	500
STF-57SPP/57SPP-8F/CMM/500M-DI065-00	Multimode	50 & 62.5/125	8	Plug	17	Plug	17	500
STF-51SPP/51SPP-2F/CMM/600M-DI065-00	Multimode	50 & 62.5/125	2	Plug	11	Plug	11	600
STF-54SPP/54SPP-4F/CMM/600M-DI065-00	Multimode	50 & 62.5/125	4	Plug	13	Plug	13	600
STF-57SPP/57SPP-8F/CMM/600M -DI065-00	Multimode	50 & 62.5/125	8	Plug	17	Plug	17	600

Note on Deployable Reel :



Above fibre optic Cable Sets are available with or without a deployable reel. To order Cable Sets with deployable reel please add suffix –R to the end of Part Number.

Example P/N WITH Reel: STF-51SPP/51SPP-8F/CMM /1KM -DI065-00-R

Example P/N WITHOUT Reel: STF-51SPP/51SPP-8F/CMM /1KM -DI065-00

Shown trademarks are property of their respective owners.

While the information contained herein in this catalog, has been carefully compiled to the best of our knowledge, nothing is intended as representation and warranty on our part; and no statement shall be construed as recommendation to infringe any of existing patents. We accept no liability of whatsoever for any faults and errors in the information contained herein. Contents of this catalogue and specifications of the products, are subject to change without notice due to continuous improvements.

Connectors Choices for MIL38999 Series Fiber Optic Cable Sets

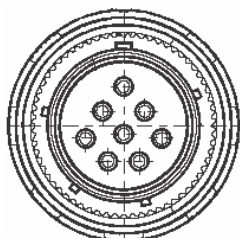

MIL-38999 Fiber Optic Plug Connectors

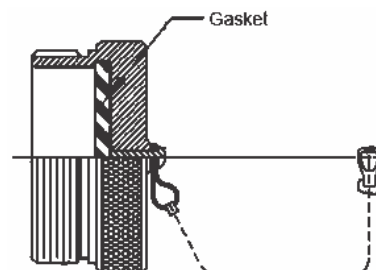
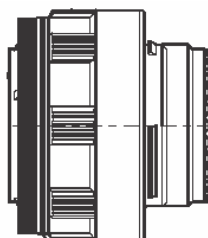

Dust Cap for MIL-38999 Fiber Optic Plug

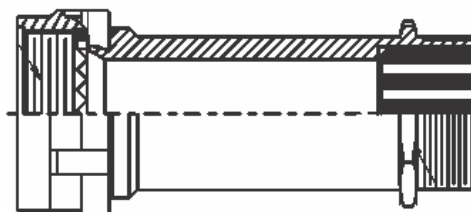

Backshell for MIL-38999 Fiber Optic Connector

Conformant to MIL-38999 & MIL-T-29504/4 and /5
Precision Ceramic ferrule
Stainless steel body
Temperature : -55°C ~ +200°C
Durability : 500 cycles
Random Vibration : per EIA/TIA 455-11, Condition 7, Letter J.
Shock : per EIA/TIA 455-14, Condition D
Temperature Life : per MIL-STD-1344, Method 1005, Condition D
Thermal Shock : per MIL-STD-1344, Method 1003, Condition A

Shown trademarks are property of their respective owners.

While the information contained herein in this catalog, has been carefully compiled to the best of our knowledge, nothing is intended as representation and warranty on our part; and no statement shall be construed as recommendation to infringe any of existing patents. We accept no liability of whatsoever for any faults and errors in the information contained herein. Contents of this catalogue and specifications of the products, are subject to change without notice due to continuous improvements.

MIL-38999 Receptacle – FC/ST/SC/LC Cable Sets for In-Box Applications

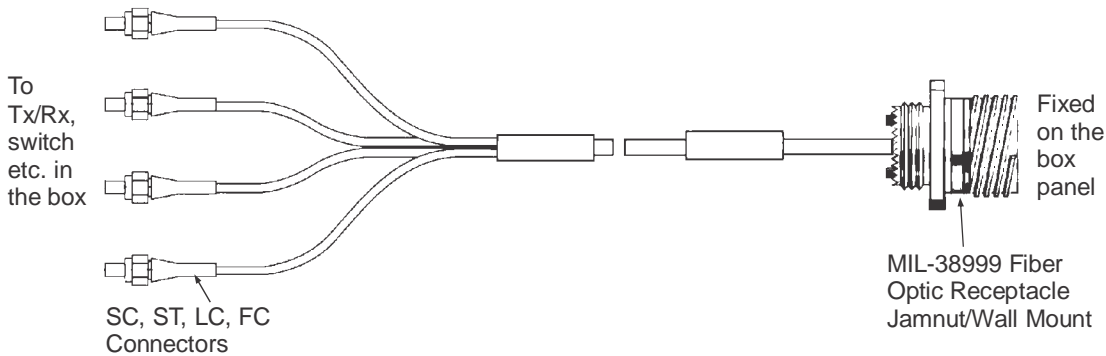

These MIL-38999 Receptacle to SC/ST/LC/FC Cable Sets are designed for MILitary applications 'inside-box'. The SC/ST/LC/FC side mates to the transceiver (or other equipment) inside the box. The MIL-38999 receptacle side is mounted on the box and is eventually mated with outside environment plug. We provide custom cable lengths, number of fibres, connectors as per choice like SC, ST, LC, FC, MT-RJ etc.

FEATURES

- Number of Fiber Channels as per choice – 1, 2, 4, 8, 12 etc
- Various combinations of MT-RJ, ST, FC, SC, LC to MIL-38999 Receptacle
- Custom cable type & lengths possible
- Singlemode 9/125um, Multimode 50/125um & 62.5/125um can be chosen
- MIL-DTL-38999 Receptacles can be Jamnut type or Wall Mount type

APPLICATIONS

- Enclosures in Radars, MILitary Systems, Ground Control Systems, Launchers etc
- Applications where equipment inside enclosure needs to be connected to outside environment
- **MIL-38999 Qualified Glenair/Amphenol** or equivalent connectors
- Imported OFNR/OFNP Grade FO cable
- Imported Hi-End FC/ST/SC/LC connectors

How to Specify Part Numbers for Cable Sets:

STF - $\square\square\square\square\square / \square\square\square\square\square - \square F / \square\square M / \square\square\square\square \square\square\square\square - 00$
A A A B C A A A B C N X X Y Y Y Y Z Z K K K

A	2 digit connector Code	09 = ST SM; 11 = ST MM 50/125; 13 = ST MM 62.5/125; 15 = SC SM; 17 = SC MM 50/125; 19 = SC MM 62.5/125; 21 = LC SM; 23 = ST LC 50/125; 25 = LC MM 62.5/125; 27 = FC SM; 29 = FC MM 50/125; 31 = FC MM 62.5/125; 9/125 Jamnut Recep: 60 = 2 ch; 63 = 4 ch ; 66 = 8 ch 50&62.5/125 Jamnut Receptacle: 69 = 2 ch; 70 = 4 ch ; 73 = 8 ch
B	Connector Type	Straight = S ; Right Angle= R ; Jamnut Receptacle = J ; Wall Mount Receptacle = W
C	Connector Style	Male/Plug = P ; Female = J
D	Termini Style	Male/Plug = P ; Female/Socket = J ; Omit if no termini
N	No. of Fibers in cable	1 = 1 fiber ; 2 = 2 fiber; 4 = 4 fiber ; 8 = 8 fiber
XX	2 digit code for mode	9S = 9/125um singlemode ; 5M = 50/125um multimode; 6M = 62.5/125um multimode ; CM = 50/125 & 62.5/125 multimode
YYY	Length (meter/Km)	100 meter = 100M ; 1 Km = 1KM ; 1 feet = 1F
ZZ	2 digit cable code	DI = Distribution Style ; BR = Breakout; RI = Riser
KKK	Cable class code	Breakout = 023; Distribution = 065; Riser = 120

1m assembly SM 9/125um, ST St.Plug both sides, 1 Fiber = STF-09SPP/09SPP-1F/9SM/1M-RI120-00

Shown trademarks are property of their respective owners.

While the information contained herein in this catalog, has been carefully compiled to the best of our knowledge, nothing is intended as representation and warranty on our part; and no statement shall be construed as recommendation to infringe any of existing patents. We accept no liability of whatsoever for any faults and errors in the information contained herein. Contents of this catalogue and specifications of the products, are subject to change without notice due to continuous improvements.

Connectors for MIL38999 Receptacle – SC/ST/LC/FC Cable Sets

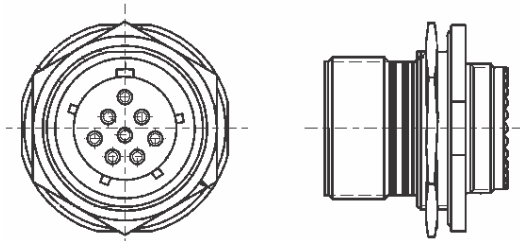

MIL-38999 Fiber Optic Jam Nut Receptacle

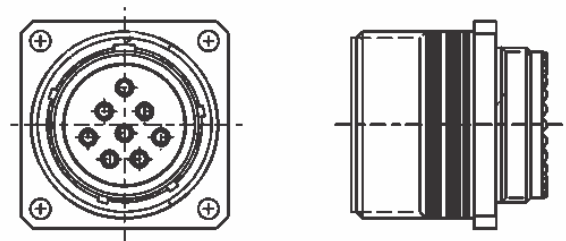

MIL-38999 Fiber Optic Wall Mount Receptacle

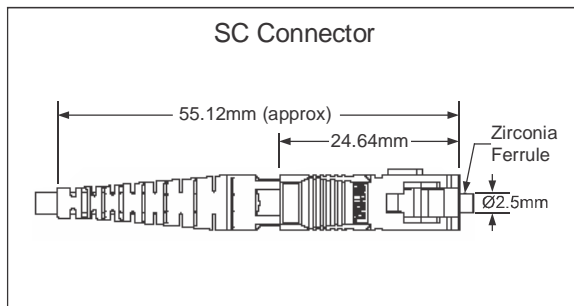

SC Connector

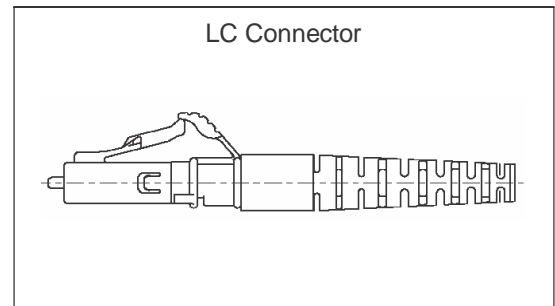

LC Connector

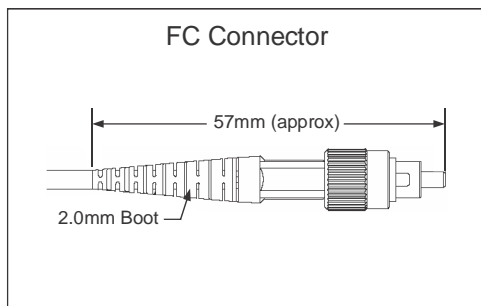

FC Connector

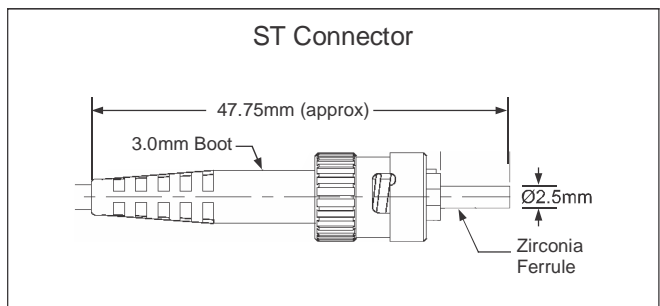

ST Connector

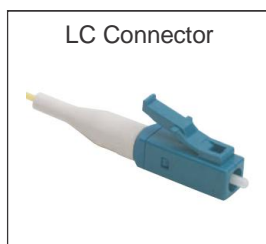

LC Connector



SC Connector



FC Connector



ST Connector

Shown trademarks are property of their respective owners.

While the information contained herein in this catalog, has been carefully compiled to the best of our knowledge, nothing is intended as representation and warranty on our part; and no statement shall be construed as recommendation to infringe any of existing patents. We accept no liability of whatsoever for any faults and errors in the information contained herein. Contents of this catalogue and specifications of the products, are subject to change without notice due to continuous improvements.

MIL-38999 Receptacle – FC/ST/SC/LC Cable Sets for In-Box Applications

MIL-38999 Jamnut Receptacle – ST Fiber Optic Cable Sets

P/N for Fiber Optic Assembly	Mode	Size	No. of Fibers	Conn. 1	Conn. 2 (38999) type size		Len. meter
STF-09SP/60JJK-2F/9SM/1M-RI120-00	Single	9/125	2	2xST(M)	Jamnut	11	1
STF-09SP/63JJK-4F/9SM/1M- RI120-00	Single	9/125	4	4xST(M)	Jamnut	13	1
STF-09SP/66JJK-8F/9SM/1M- RI120-00	Single	9/125	8	8xST(M)	Jamnut	17	1
STF-09SP/60JJK-2F/9SM/2M-RI120-00	Single	9/125	2	2xST(M)	Jamnut	11	2
STF-09SP/63JJK-4F/9SM/2M- RI120-00	Single	9/125	4	4xST(M)	Jamnut	13	2
STF-09SP/66JJK-8F/9SM/2M- RI120-00	Single	9/125	8	8xST(M)	Jamnut	17	2
STF-09SP/60JJK-2F/9SM/3M-RI120-00	Single	9/125	2	2xST(M)	Jamnut	11	3
STF-09SP/63JJK-4F/9SM/3M- RI120-00	Single	9/125	4	4xST(M)	Jamnut	13	3
STF-09SP/66JJK-8F/9SM/3M- RI120-00	Single	9/125	8	8xST(M)	Jamnut	17	3
STF-09SP/60JJK-2F/9SM/5M-RI120-00	Single	9/125	2	2xST(M)	Jamnut	11	5
STF-09SP/63JJK-4F/9SM/5M- RI120-00	Single	9/125	4	4xST(M)	Jamnut	13	5
STF-09SP/66JJK-8F/9SM/5M- RI120-00	Single	9/125	8	8xST(M)	Jamnut	17	5
STF-11SP/69JJK-2F/5MM/1M-RI120-00	Multi	50/125	2	2xST(M)	Jamnut	11	1
STF-11SP/70JJK-4F/5MM/1M-RI120-00	Multi	50/125	4	4xST(M)	Jamnut	13	1
STF-11SP/73JJK-8F/5MM/1M-RI120-00	Multi	50/125	8	8xST(M)	Jamnut	17	1
STF-11SP/69JJK-2F/5MM/2M-RI120-00	Multi	50/125	2	2xST(M)	Jamnut	11	2
STF-11SP/70JJK-4F/5MM/2M-RI120-00	Multi	50/125	4	4xST(M)	Jamnut	13	2
STF-11SP/73JJK-8F/5MM/2M-RI120-00	Multi	50/125	8	8xST(M)	Jamnut	17	2
STF-11SP/69JJK-2F/5MM/3M-RI120-00	Multi	50/125	2	2xST(M)	Jamnut	11	3
STF-11SP/70JJK-4F/5MM/3M-RI120-00	Multi	50/125	4	4xST(M)	Jamnut	13	3
STF-11SP/73JJK-8F/5MM/3M-RI120-00	Multi	50/125	8	8xST(M)	Jamnut	17	3
STF-11SP/69JJK-2F/5MM/5M-RI120-00	Multi	50/125	2	2xST(M)	Jamnut	11	5
STF-11SP/70JJK-4F/5MM/5M-RI120-00	Multi	50/125	4	4xST(M)	Jamnut	13	5
STF-11SP/73JJK-8F/5MM/5M-RI120-00	Multi	50/125	8	8xST(M)	Jamnut	17	5
STF-13SP/69JJK-2F/6MM/1M-RI120-00	Multi	62.5/125	2	2xST(M)	Jamnut	11	1
STF-13SP/70JJK-4F/6MM/1M-RI120-00	Multi	62.5/125	4	4xST(M)	Jamnut	13	1
STF-13SP/73JJK-8F/6MM/1M-RI120-00	Multi	62.5/125	8	8xST(M)	Jamnut	17	1
STF-13SP/69JJK-2F/6MM/2M-RI120-00	Multi	62.5/125	2	2xST(M)	Jamnut	11	2
STF-13SP/70JJK-4F/6MM/2M-RI120-00	Multi	62.5/125	4	4xST(M)	Jamnut	13	2
STF-13SP/73JJK-8F/6MM/2M-RI120-00	Multi	62.5/125	8	8xST(M)	Jamnut	17	2
STF-13SP/69JJK-2F/6MM/3M-RI120-00	Multi	62.5/125	2	2xST(M)	Jamnut	11	3
STF-13SP/70JJK-4F/6MM/3M-RI120-00	Multi	62.5/125	4	4xST(M)	Jamnut	13	3
STF-13SP/73JJK-8F/6MM/3M-RI120-00	Multi	62.5/125	8	8xST(M)	Jamnut	17	3
STF-13SP/69JJK-2F/6MM/5M-RI120-00	Multi	62.5/125	2	2xST(M)	Jamnut	11	5
STF-13SP/70JJK-4F/6MM/5M-RI120-00	Multi	62.5/125	4	4xST(M)	Jamnut	13	5
STF-13SP/73JJK-8F/6MM/5M-RI120-00	Multi	62.5/125	8	8xST(M)	Jamnut	17	5

Shown trademarks are property of their respective owners.

While the information contained herein in this catalog, has been carefully compiled to the best of our knowledge, nothing is intended as representation and warranty on our part; and no statement shall be construed as recommendation to infringe any of existing patents. We accept no liability of whatsoever for any faults and errors in the information contained herein. Contents of this catalogue and specifications of the products, are subject to change without notice due to continuous improvements.

MIL-38999 Jamnut Receptacle – SC Fiber Optic Cable Sets

P/N for Fiber Optic Assembly	Mode	Size	No. of Fibers	Conn. 1	Conn. 2 (38999)		Len. meter
					type	size	
STF-15SP/60JJJ-2F/9SM/1M-RI120-00	Single	9/125	2	2xSC(M)	Jamnut	11	1
STF-15SP/63JJJ-4F/9SM/1M- RI120-00	Single	9/125	4	4xSC(M)	Jamnut	13	1
STF-15SP/66JJJ-8F/9SM/1M- RI120-00	Single	9/125	8	8xSC(M)	Jamnut	17	1
STF-15SP/60JJJ-2F/9SM/2M-RI120-00	Single	9/125	2	2xSC(M)	Jamnut	11	2
STF-15SP/63JJJ-4F/9SM/2M- RI120-00	Single	9/125	4	4xSC(M)	Jamnut	13	2
STF-15SP/66JJJ-8F/9SM/2M- RI120-00	Single	9/125	8	8xSC(M)	Jamnut	17	2
STF-15SP/60JJJ-2F/9SM/3M-RI120-00	Single	9/125	2	2xSC(M)	Jamnut	11	3
STF-15SP/63JJJ-4F/9SM/3M- RI120-00	Single	9/125	4	4xSC(M)	Jamnut	13	3
STF-15SP/66JJJ-8F/9SM/3M- RI120-00	Single	9/125	8	8xSC(M)	Jamnut	17	3
STF-15SP/60JJJ-2F/9SM/5M-RI120-00	Single	9/125	2	2xSC(M)	Jamnut	11	5
STF-15SP/63JJJ-4F/9SM/5M- RI120-00	Single	9/125	4	4xSC(M)	Jamnut	13	5
STF-15SP/66JJJ-8F/9SM/5M- RI120-00	Single	9/125	8	8xSC(M)	Jamnut	17	5
STF-17SP/69JJJ-2F/5MM/1M-RI120-00	Multi	50/125	2	2xSC(M)	Jamnut	11	1
STF-17SP/70JJJ-4F/5MM/1M-RI120-00	Multi	50/125	4	4xSC(M)	Jamnut	13	1
STF-17SP/73JJJ-8F/5MM/1M-RI120-00	Multi	50/125	8	8xSC(M)	Jamnut	17	1
STF-17SP/69JJJ-2F/5MM/2M-RI120-00	Multi	50/125	2	2xSC(M)	Jamnut	11	2
STF-17SP/70JJJ-4F/5MM/2M-RI120-00	Multi	50/125	4	4xSC(M)	Jamnut	13	2
STF-17SP/73JJJ-8F/5MM/2M-RI120-00	Multi	50/125	8	8xSC(M)	Jamnut	17	2
STF-17SP/69JJJ-2F/5MM/3M-RI120-00	Multi	50/125	2	2xSC(M)	Jamnut	11	3
STF-17SP/70JJJ-4F/5MM/3M-RI120-00	Multi	50/125	4	4xSC(M)	Jamnut	13	3
STF-17SP/73JJJ-8F/5MM/3M-RI120-00	Multi	50/125	8	8xSC(M)	Jamnut	17	3
STF-17SP/69JJJ-2F/5MM/5M-RI120-00	Multi	50/125	2	2xSC(M)	Jamnut	11	5
STF-17SP/70JJJ-4F/5MM/5M-RI120-00	Multi	50/125	4	4xSC(M)	Jamnut	13	5
STF-17SP/73JJJ-8F/5MM/5M-RI120-00	Multi	50/125	8	8xSC(M)	Jamnut	17	5
STF-19SP/69JJJ-2F/6MM/1M-RI120-00	Multi	62.5/125	2	2xSC(M)	Jamnut	11	1
STF-19SP/70JJJ-4F/6MM/1M-RI120-00	Multi	62.5/125	4	4xSC(M)	Jamnut	13	1
STF-19SP/73JJJ-8F/6MM/1M-RI120-00	Multi	62.5/125	8	8xSC(M)	Jamnut	17	1
STF-19SP/69JJJ-2F/6MM/2M-RI120-00	Multi	62.5/125	2	2xSC(M)	Jamnut	11	2
STF-19SP/70JJJ-4F/6MM/2M-RI120-00	Multi	62.5/125	4	4xSC(M)	Jamnut	13	2
STF-19SP/73JJJ-8F/6MM/2M-RI120-00	Multi	62.5/125	8	8xSC(M)	Jamnut	17	2
STF-19SP/69JJJ-2F/6MM/3M-RI120-00	Multi	62.5/125	2	2xSC(M)	Jamnut	11	3
STF-19SP/70JJJ-4F/6MM/3M-RI120-00	Multi	62.5/125	4	4xSC(M)	Jamnut	13	3
STF-19SP/73JJJ-8F/6MM/3M-RI120-00	Multi	62.5/125	8	8xSC(M)	Jamnut	17	3
STF-19SP/69JJJ-2F/6MM/5M-RI120-00	Multi	62.5/125	2	2xSC(M)	Jamnut	11	5
STF-19SP/70JJJ-4F/6MM/5M-RI120-00	Multi	62.5/125	4	4xSC(M)	Jamnut	13	5
STF-19SP/73JJJ-8F/6MM/5M-RI120-00	Multi	62.5/125	8	8xSC(M)	Jamnut	17	5

Shown trademarks are property of their respective owners.

While the information contained herein in this catalog, has been carefully compiled to the best of our knowledge, nothing is intended as representation and warranty on our part; and no statement shall be construed as recommendation to infringe any of existing patents. We accept no liability of whatsoever for any faults and errors in the information contained herein. Contents of this catalogue and specifications of the products, are subject to change without notice due to continuous improvements.

MIL-38999 Receptacle – FC/ST/SC/LC Cable Sets for In-Box Applications

MIL-38999 Jamnut Receptacle – LC Fiber Optic Cable Sets

P/N for Fiber Optic Assembly	Mode	Size	No. of Fibers	Conn. 1	Conn. 2 (38999) type size		Len. meter
STF-21SP/60JJJ-2F/9SM/1M-RI120-00	Single	9/125	2	2xLC(M)	Jamnut	11	1
STF-21SP/63JJJ-4F/9SM/1M- RI120-00	Single	9/125	4	4xLC(M)	Jamnut	13	1
STF-21SP/66JJJ-8F/9SM/1M- RI120-00	Single	9/125	8	8xLC(M)	Jamnut	17	1
STF-21SP/60JJJ-2F/9SM/2M-RI120-00	Single	9/125	2	2xLC(M)	Jamnut	11	2
STF-21SP/63JJJ-4F/9SM/2M- RI120-00	Single	9/125	4	4xLC(M)	Jamnut	13	2
STF-21SP/66JJJ-8F/9SM/2M- RI120-00	Single	9/125	8	8xLC(M)	Jamnut	17	2
STF-21SP/60JJJ-2F/9SM/3M-RI120-00	Single	9/125	2	2xLC(M)	Jamnut	11	3
STF-21SP/63JJJ-4F/9SM/3M- RI120-00	Single	9/125	4	4xLC(M)	Jamnut	13	3
STF-21SP/66JJJ-8F/9SM/3M- RI120-00	Single	9/125	8	8xLC(M)	Jamnut	17	3
STF-21SP/60JJJ-2F/9SM/5M-RI120-00	Single	9/125	2	2xLC(M)	Jamnut	11	5
STF-21SP/63JJJ-4F/9SM/5M- RI120-00	Single	9/125	4	4xLC(M)	Jamnut	13	5
STF-21SP/66JJJ-8F/9SM/5M- RI120-00	Single	9/125	8	8xLC(M)	Jamnut	17	5
STF-23SP/69JJJ-2F/5MM/1M-RI120-00	Multi	50/125	2	2xLC(M)	Jamnut	11	1
STF-23SP/70JJJ-4F/5MM/1M-RI120-00	Multi	50/125	4	4xLC(M)	Jamnut	13	1
STF-23SP/73JJJ-8F/5MM/1M-RI120-00	Multi	50/125	8	8xLC(M)	Jamnut	17	1
STF-23SP/69JJJ-2F/5MM/2M-RI120-00	Multi	50/125	2	2xLC(M)	Jamnut	11	2
STF-23SP/70JJJ-4F/5MM/2M-RI120-00	Multi	50/125	4	4xLC(M)	Jamnut	13	2
STF-23SP/73JJJ-8F/5MM/2M-RI120-00	Multi	50/125	8	8xLC(M)	Jamnut	17	2
STF-23SP/69JJJ-2F/5MM/3M-RI120-00	Multi	50/125	2	2xLC(M)	Jamnut	11	3
STF-23SP/70JJJ-4F/5MM/3M-RI120-00	Multi	50/125	4	4xLC(M)	Jamnut	13	3
STF-23SP/73JJJ-8F/5MM/3M-RI120-00	Multi	50/125	8	8xLC(M)	Jamnut	17	3
STF-23SP/69JJJ-2F/5MM/5M-RI120-00	Multi	50/125	2	2xLC(M)	Jamnut	11	5
STF-23SP/70JJJ-4F/5MM/5M-RI120-00	Multi	50/125	4	4xLC(M)	Jamnut	13	5
STF-23SP/73JJJ-8F/5MM/5M-RI120-00	Multi	50/125	8	8xLC(M)	Jamnut	17	5
STF-25SP/69JJJ-2F/6MM/1M-RI120-00	Multi	62.5/125	2	2xLC(M)	Jamnut	11	1
STF-25SP/70JJJ-4F/6MM/1M-RI120-00	Multi	62.5/125	4	4xLC(M)	Jamnut	13	1
STF-25SP/73JJJ-8F/6MM/1M-RI120-00	Multi	62.5/125	8	8xLC(M)	Jamnut	17	1
STF-25SP/69JJJ-2F/6MM/2M-RI120-00	Multi	62.5/125	2	2xLC(M)	Jamnut	11	2
STF-25SP/70JJJ-4F/6MM/2M-RI120-00	Multi	62.5/125	4	4xLC(M)	Jamnut	13	2
STF-25SP/73JJJ-8F/6MM/2M-RI120-00	Multi	62.5/125	8	8xLC(M)	Jamnut	17	2
STF-25SP/69JJJ-2F/6MM/3M-RI120-00	Multi	62.5/125	2	2xLC(M)	Jamnut	11	3
STF-25SP/70JJJ-4F/6MM/3M-RI120-00	Multi	62.5/125	4	4xLC(M)	Jamnut	13	3
STF-25SP/73JJJ-8F/6MM/3M-RI120-00	Multi	62.5/125	8	8xLC(M)	Jamnut	17	3
STF-25SP/69JJJ-2F/6MM/5M-RI120-00	Multi	62.5/125	2	2xLC(M)	Jamnut	11	5
STF-25SP/70JJJ-4F/6MM/5M-RI120-00	Multi	62.5/125	4	4xLC(M)	Jamnut	13	5
STF-25SP/73JJJ-8F/6MM/5M-RI120-00	Multi	62.5/125	8	8xLC(M)	Jamnut	17	5

Shown trademarks are property of their respective owners.

While the information contained herein in this catalog, has been carefully compiled to the best of our knowledge, nothing is intended as representation and warranty on our part; and no statement shall be construed as recommendation to infringe any of existing patents. We accept no liability of whatsoever for any faults and errors in the information contained herein. Contents of this catalogue and specifications of the products, are subject to change without notice due to continuous improvements.